

Control aircon by monitoring temperature in other parts of the room

Sheet:
File: Pine.kicad_pcb

Title: *Pine@Hutscape*

Size: A4 Date: 2020-09-16
KiCad E.D.A. kicad (5.1.6-0-10_14)

Rev: V1.2
Id: 1/1

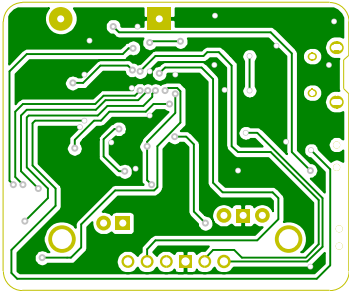

Control aircon by monitoring temperature in other parts of the room

Sheet:
File: Pine.kicad_pcb

Title: *Pine@Hutscape*

Size: A4 Date: 2020-09-16

KiCad E.D.A. kicad (5.1.6-0-10_14)

Rev: V1.2

Id: 1/1

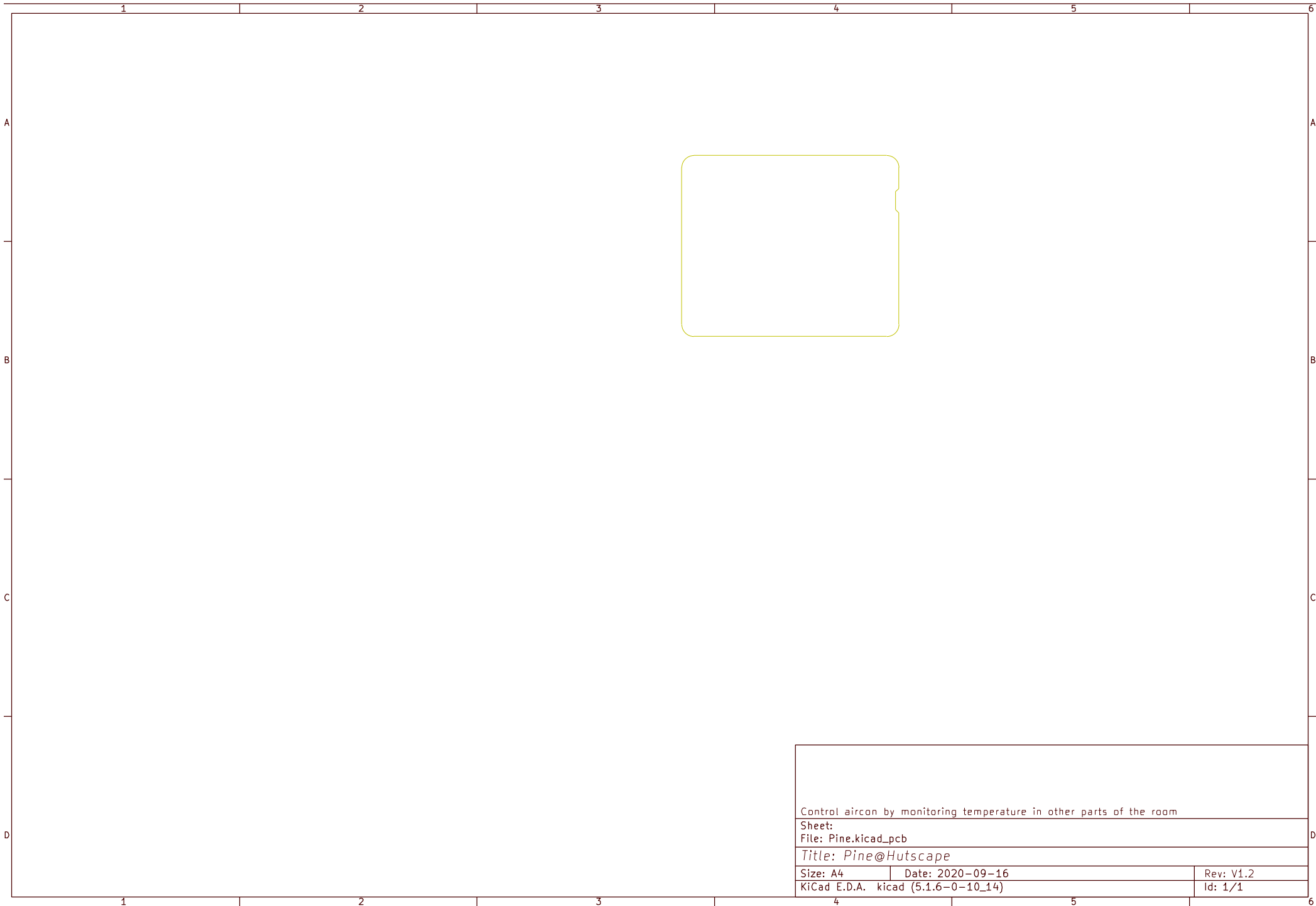

Control aircon by monitoring temperature in other parts of the room

Sheet:

File: Pine.kicad_pcb

Title: *Pine@Hutscape*

Size: A4 Date: 2020-09-16

KiCad E.D.A. kicad (5.1.6-0-10_14)

Rev: V1.2

Id: 1/1

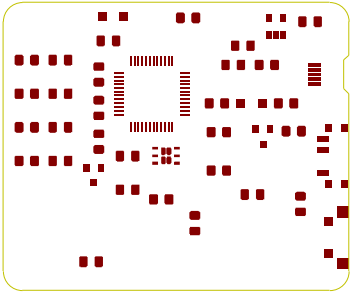
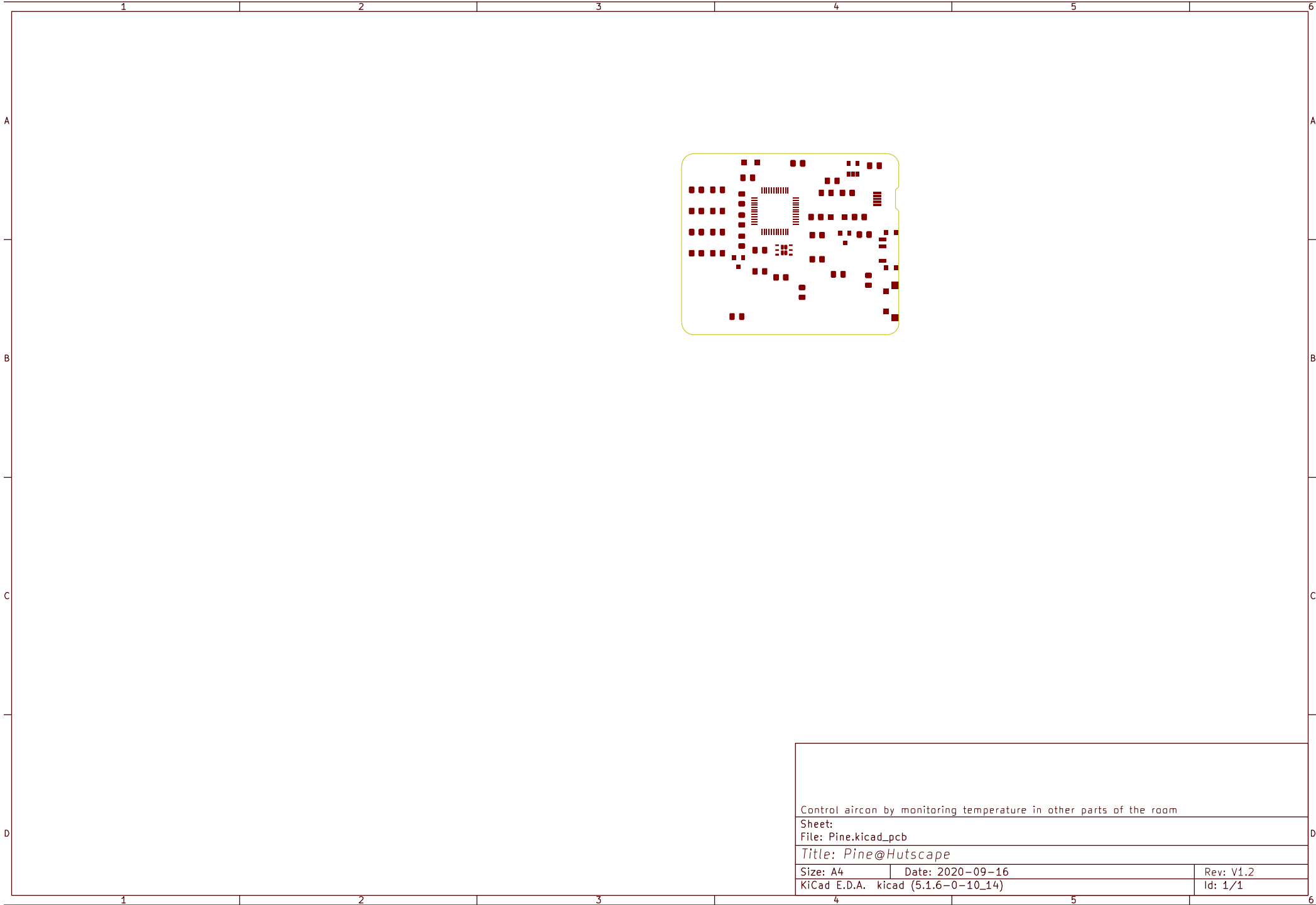

Control aircon by monitoring temperature in other parts of the room

Sheet:
File: Pine.kicad_pcb

Title: *Pine@Hutscape*

Size: A4 Date: 2020-09-16

KiCad E.D.A. kicad (5.1.6-0-10_14)

Rev: V1.2

Id: 1/1

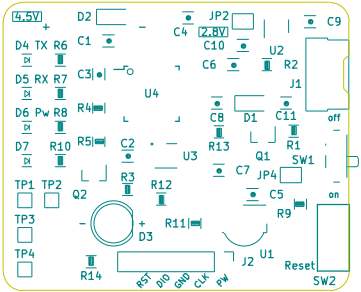

Control aircon by monitoring temperature in other parts of the room

Sheet:
File: Pine.kicad_pcb

Title: *Pine@Hutscape*

Size: A4 Date: 2020-09-16

KiCad E.D.A. kicad (5.1.6-0-10_14)

Rev: V1.2

Id: 1/1

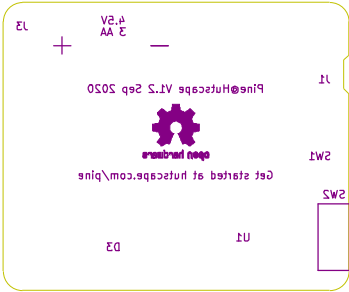

Control aircon by monitoring temperature in other parts of the room

Sheet:
File: Pine.kicad_pcb

Title: *Pine@Hutscape*

Size: A4 Date: 2020-09-16

KiCad E.D.A. kicad (5.1.6-0-10_14)

Rev: V1.2

Id: 1/1

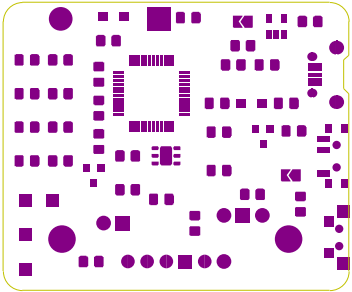

Control aircon by monitoring temperature in other parts of the room

Sheet:
File: Pine.kicad_pcb

Title: *Pine@Hutscape*

Size: A4 Date: 2020-09-16

KiCad E.D.A. kicad (5.1.6-0-10_14)

Rev: V1.2

Id: 1/1

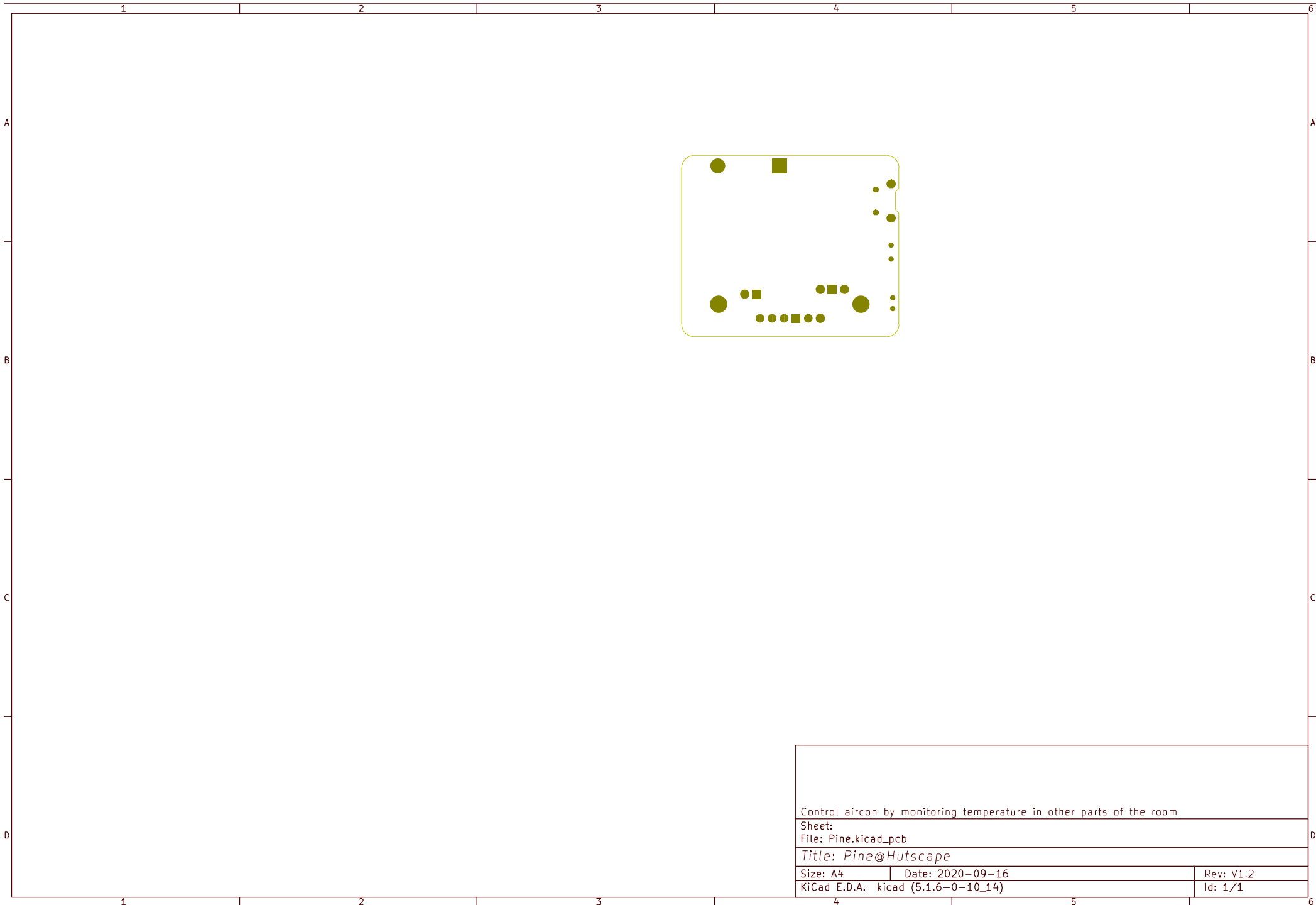

Control aircon by monitoring temperature in other parts of the room		
Sheet:		
File: Pine.kicad_pcb		
Title: <i>Pine@Hutscape</i>		
Size: A4	Date: 2020-09-16	Rev: V1.2
KiCad E.D.A. kicad (5.1.6-0-10_14)		Id: 1/1

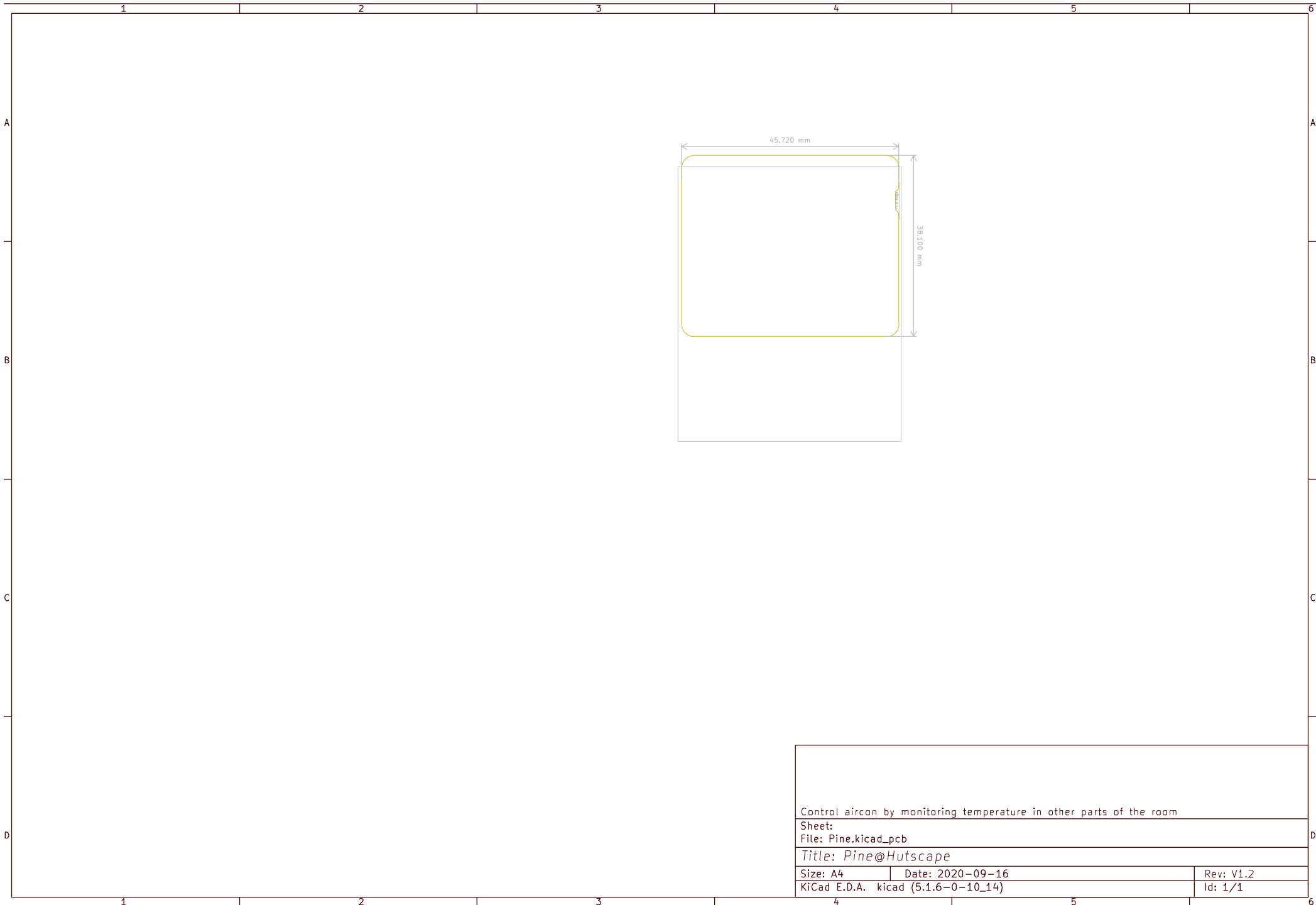

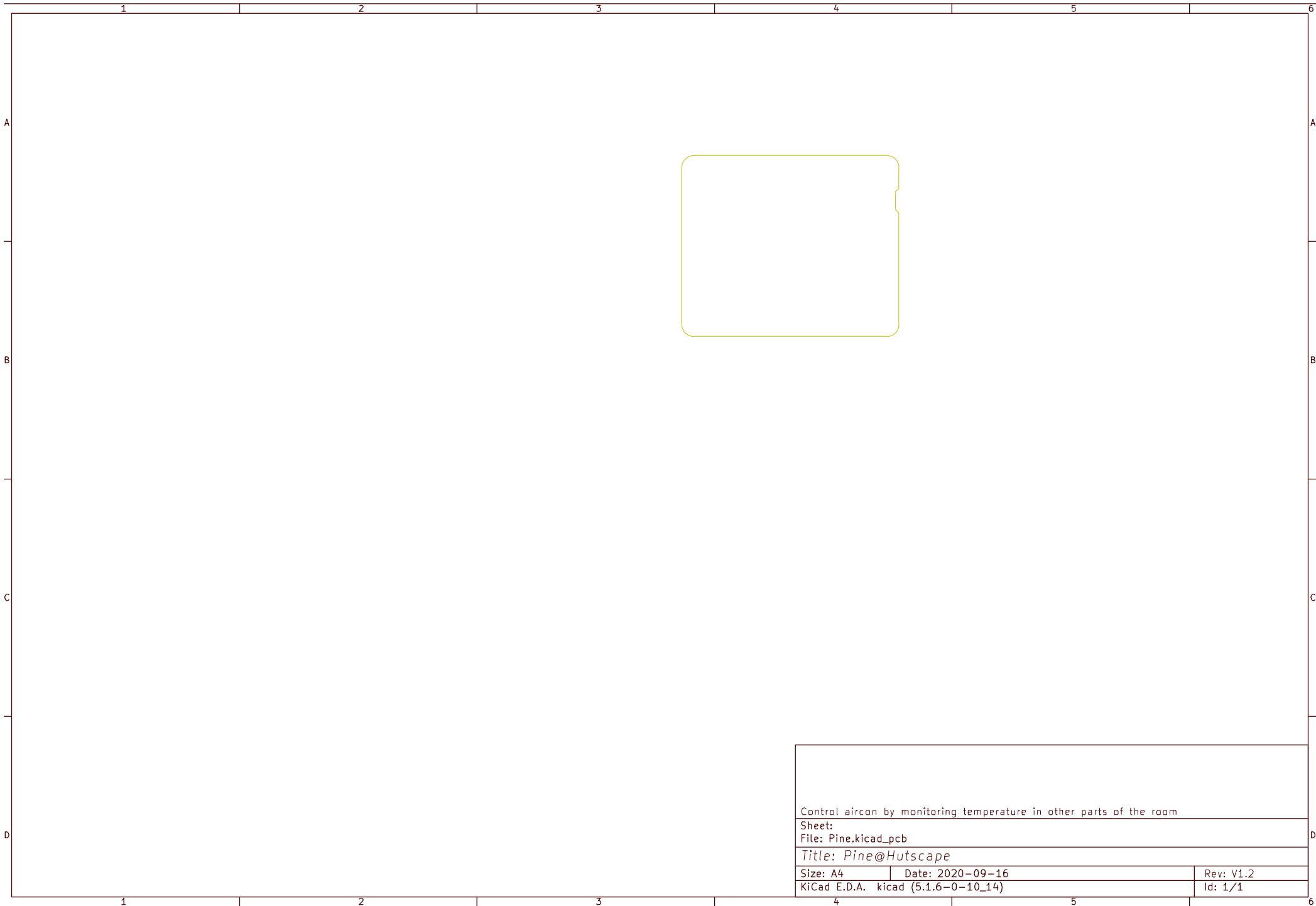

Control aircon by monitoring temperature in other parts of the room

Sheet:

File: Pine.kicad_pcb

Title: *Pine@Hutscape*

Size: A4 Date: 2020-09-16

KiCad E.D.A. kicad (5.1.6-0-10_14)

Rev: V1.2

Id: 1/1

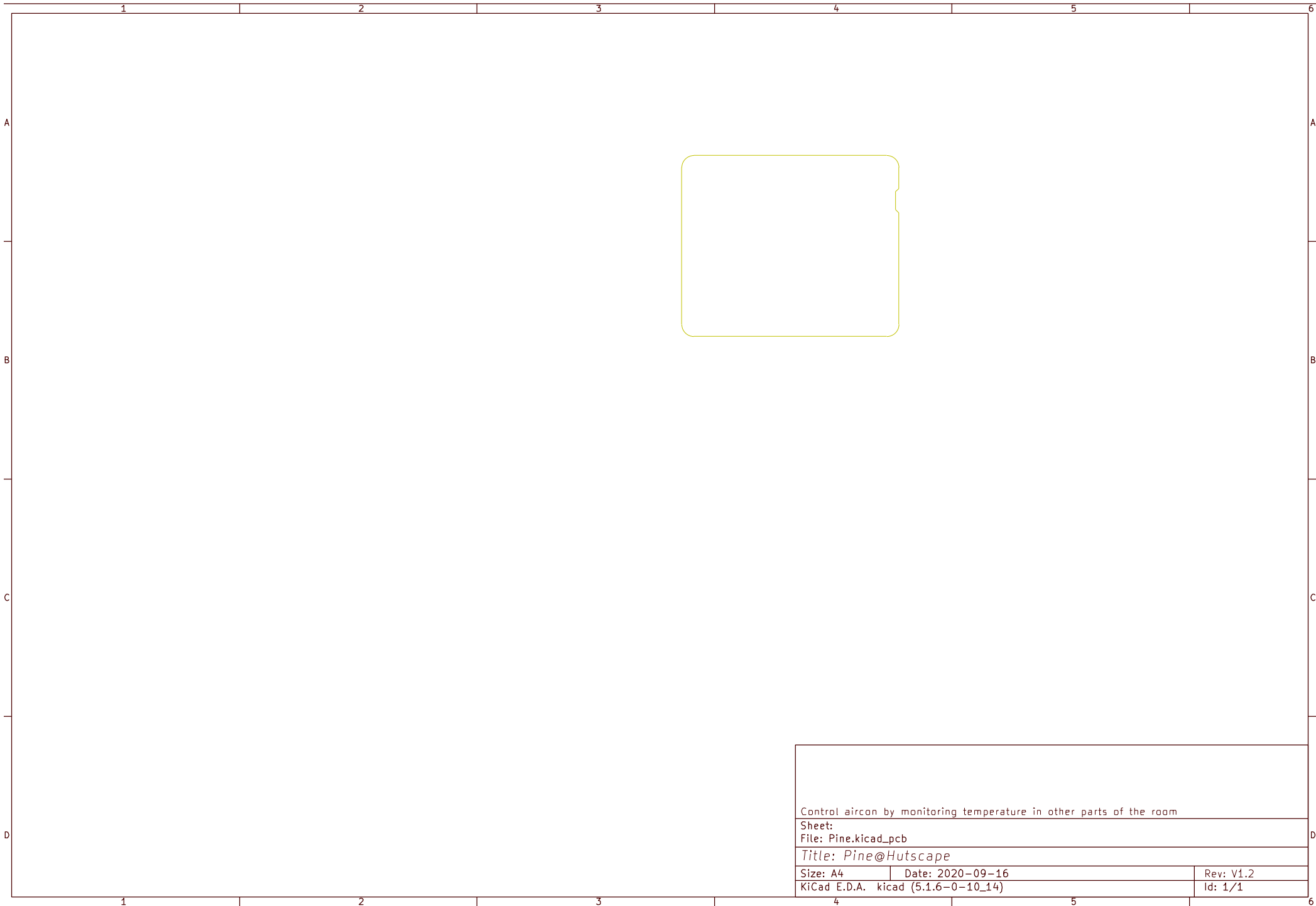

Control aircon by monitoring temperature in other parts of the room

Sheet:

File: Pine.kicad_pcb

Title: *Pine@Hutscape*

Size: A4 Date: 2020-09-16

KiCad E.D.A. kicad (5.1.6-0-10_14)

Rev: V1.2

Id: 1/1

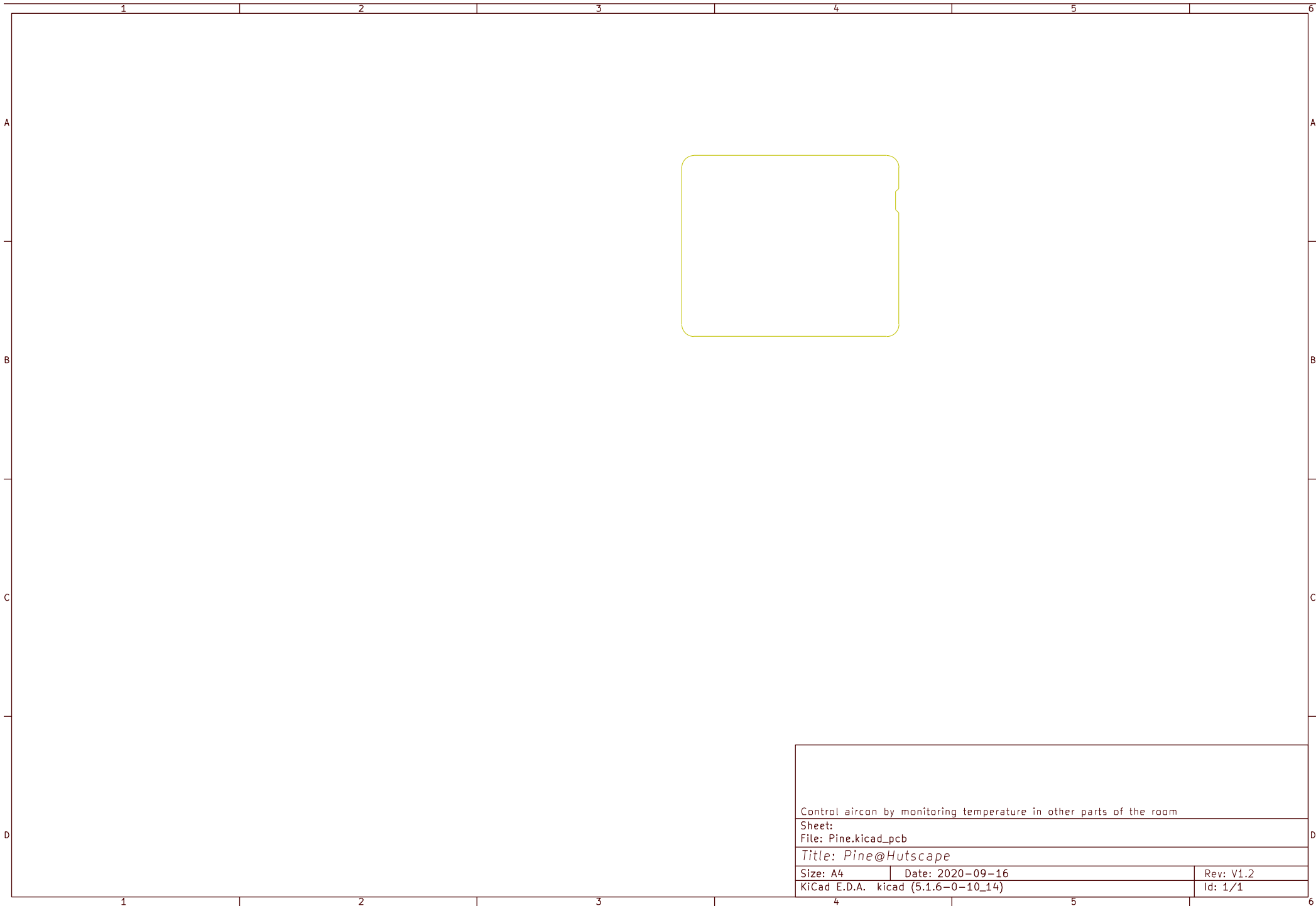

Control aircon by monitoring temperature in other parts of the room

Sheet:

File: Pine.kicad_pcb

Title: *Pine@Hutscape*

Size: A4

Date: 2020-09-16

Rev: V1.2

KiCad E.D.A. kicad (5.1.6-0-10_14)

Id: 1/1

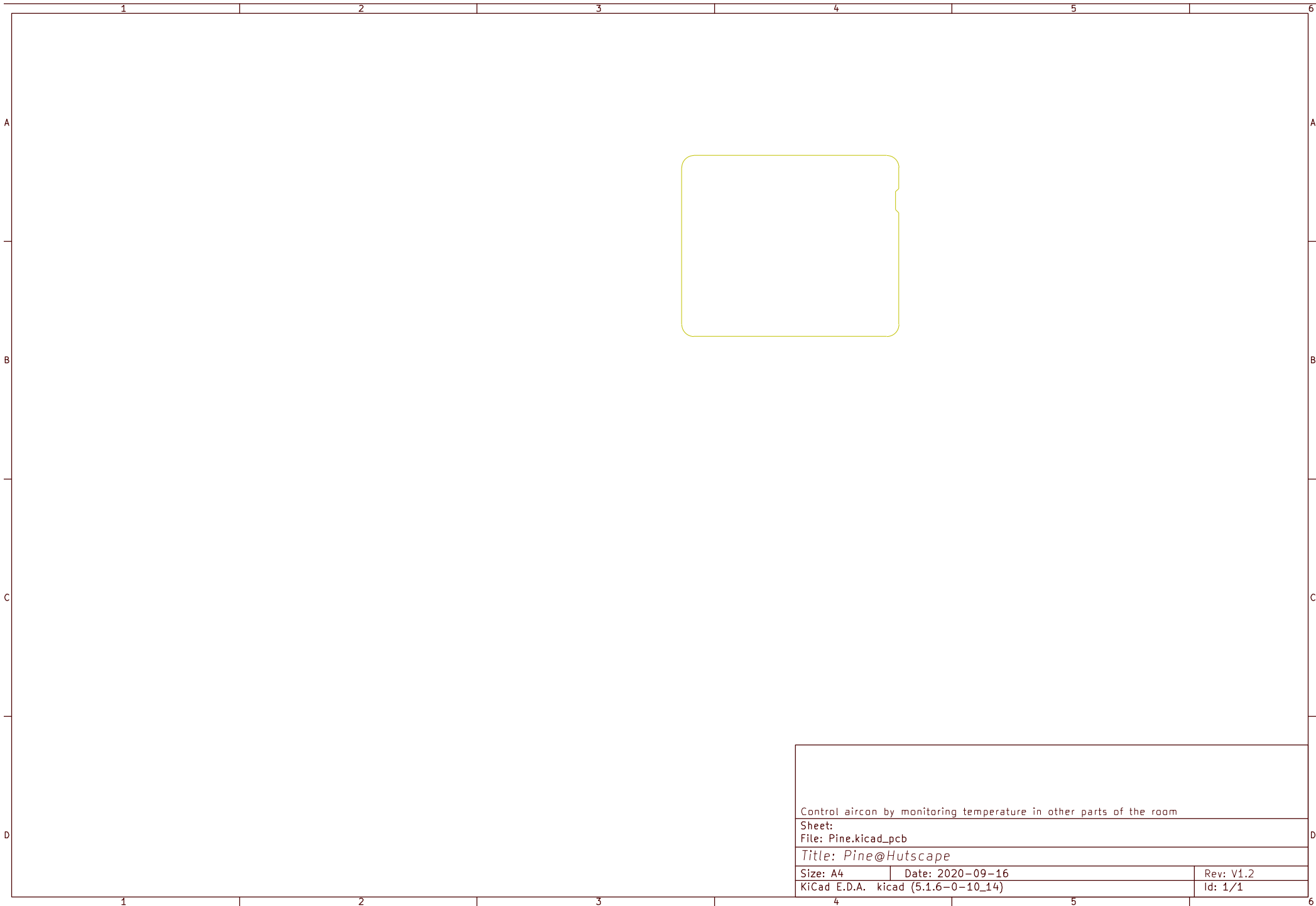

Control aircon by monitoring temperature in other parts of the room

Sheet:

File: Pine.kicad_pcb

Title: *Pine@Hutscape*

Size: A4 Date: 2020-09-16

KiCad E.D.A. kicad (5.1.6-0-10_14)

Rev: V1.2

Id: 1/1

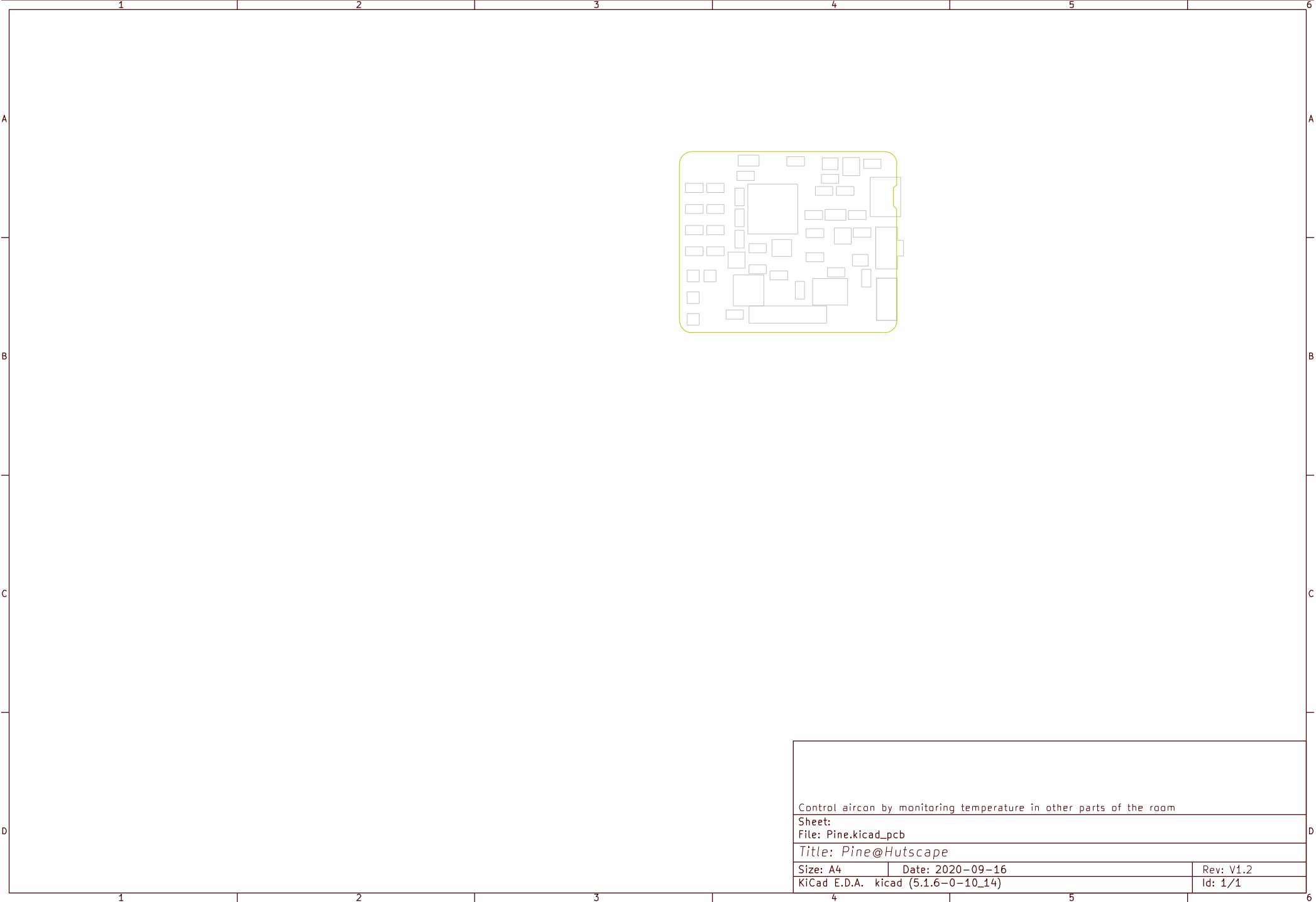

Control aircon by monitoring temperature in other parts of the room		
Sheet:		
File: Pine.kicad_pcb		
Title: <i>Pine@Hutscape</i>		
Size: A4	Date: 2020-09-16	Rev: V1.2
KiCad E.D.A. kicad (5.1.6-0-10_14)		Id: 1/1

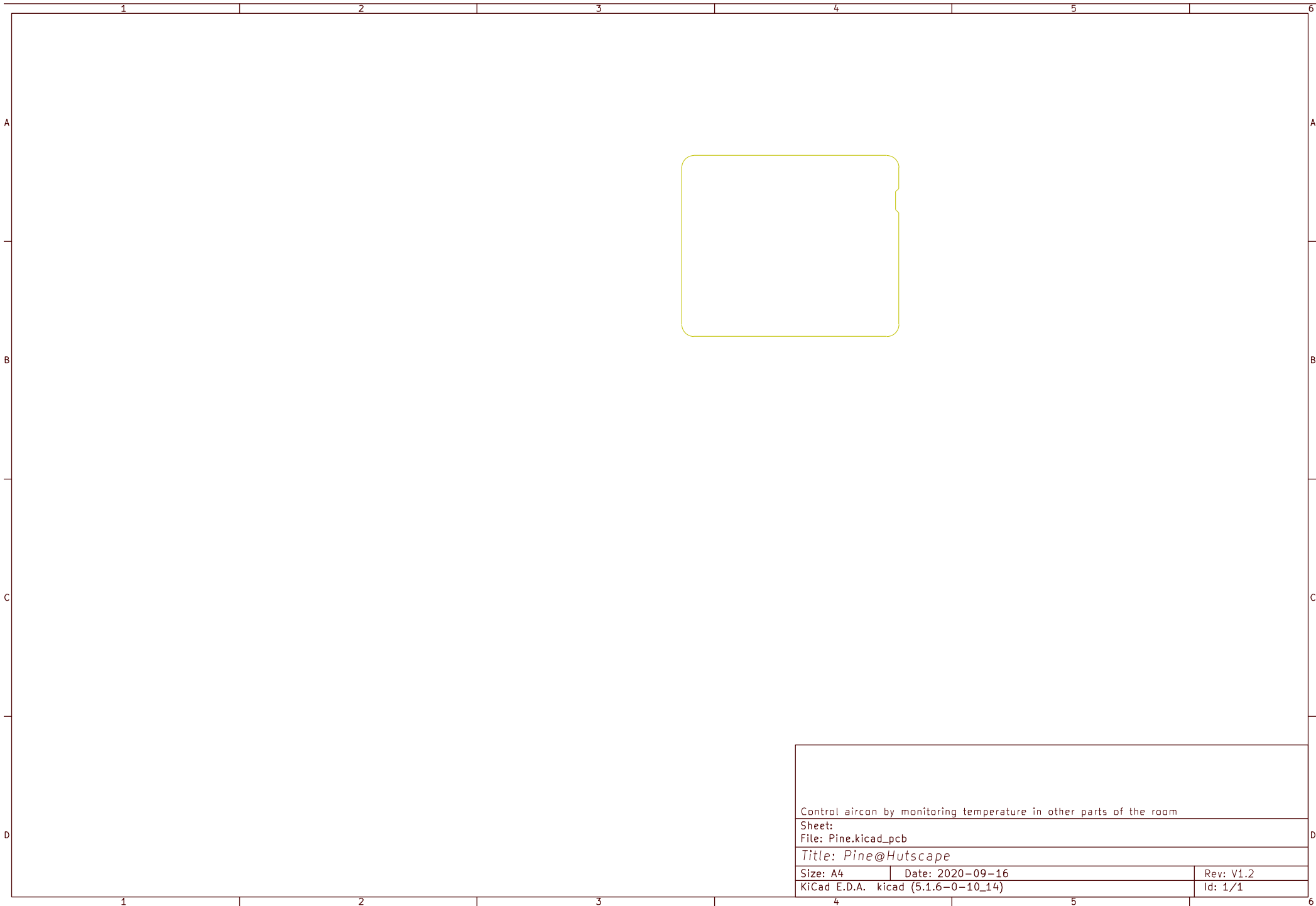

Control aircon by monitoring temperature in other parts of the room

Sheet:

File: Pine.kicad_pcb

Title: *Pine@Hutscape*

Size: A4 Date: 2020-09-16

KiCad E.D.A. kicad (5.1.6-0-10_14)

Rev: V1.2

Id: 1/1

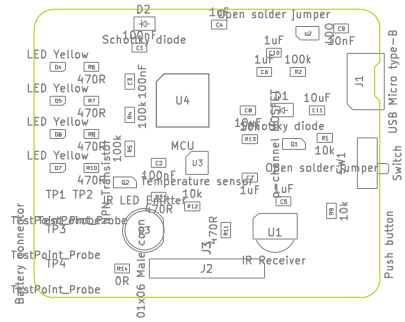

Control aircon by monitoring temperature in other parts of the room

Sheet:
File: Pine.kicad_pcb

Title: *Pine@Hutscape*

Size: A4 | Date: 2020-09-16

KiCad E.D.A. kicad (5.1.6-0-10_14)

Rev: V1.2

Id: 1/1

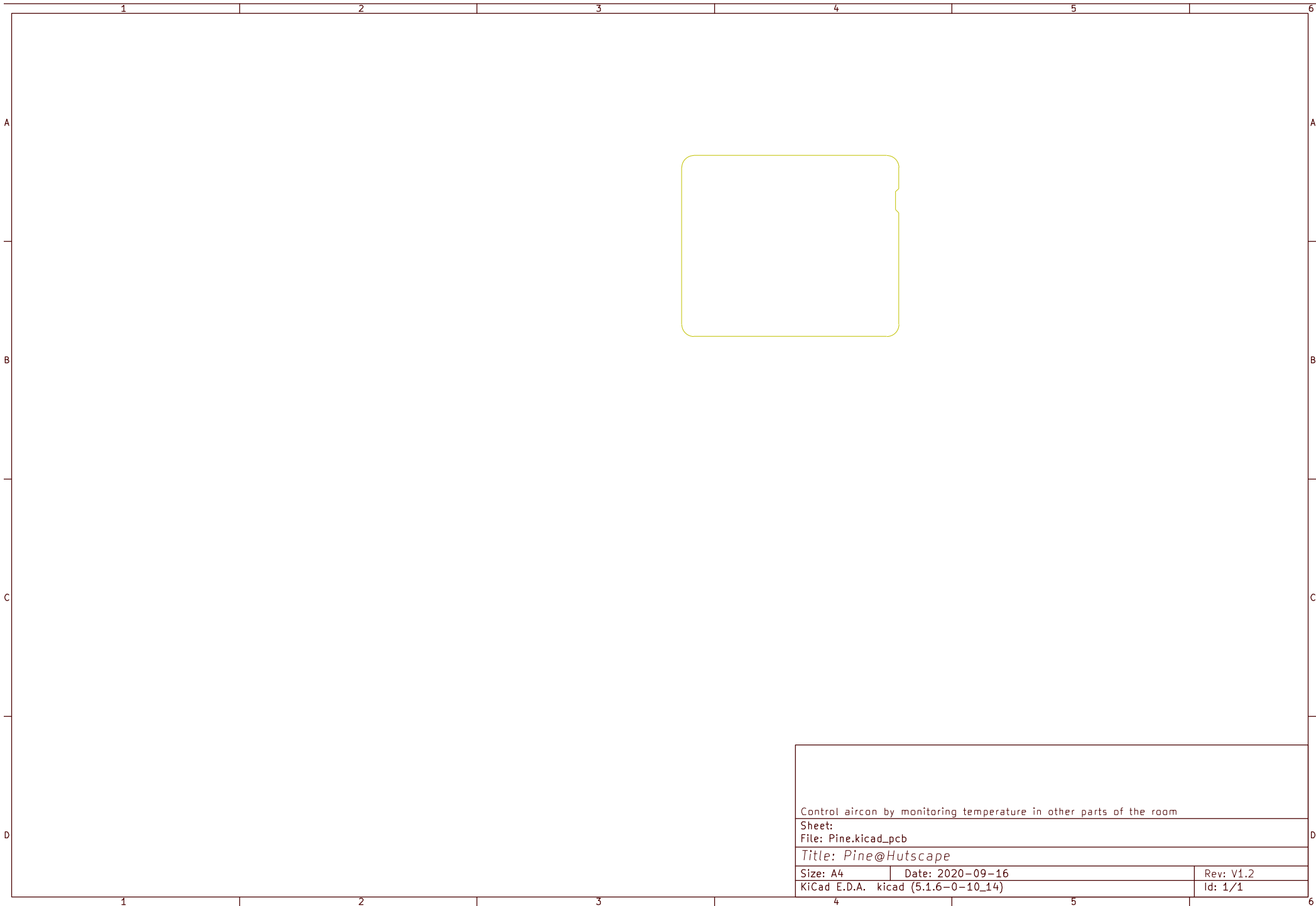

Control aircon by monitoring temperature in other parts of the room

Sheet:

File: Pine.kicad_pcb

Title: *Pine@Hutscape*

Size: A4 Date: 2020-09-16

KiCad E.D.A. kicad (5.1.6-0-10_14)

Rev: V1.2

Id: 1/1